





RM85 105 °C sensitive miniature relays



AMBIENT
TEMPERATURE
up to 105 °C

- Relays designed for continuous operation*
- CTI 250
- For PCB and plug-in sockets
- DC coils - sensitive 0,25 W, insulation class F: 155 °C
- Applications: in household equipment, in temperature controllers
- Compliance with standard EN 60335-1
- Recognitions, certifications, directives: RoHS,     

Contact data

Number and type of contacts		1 NO
Contact material		AgNi, AgNi/Au hard gold plating, AgSnO₂
Rated / max. switching voltage	AC	250 V / 400 V
Min. switching voltage		5 V AgNi, 5 V AgNi/Au hard gold plating, 10 V AgSnO ₂
Rated load (capacity)	AC1	16 A / 250 V AC
	AC15	3 A / 120 V 1,5 A / 240 V (B300)
	DC1	16 A / 24 V DC (see Fig. 2)
	DC13	0,22 A / 120 V 0,1 A / 250 V (R300)
Motor load	acc. to UL 508	1/2 HP 240 V AC, 4,9 FLA, single-phase motor 1
	AC3 acc. to IEC 60947-4-1	0,5 kW 240 V AC, single-phase motor
Min. switching current		5 mA AgNi, 2 mA AgNi/Au hard gold plating, 10 mA AgSnO ₂
Max. make current		30 A AgSnO ₂
Rated current		16 A
Max. breaking capacity	AC1	4 000 VA
Min. breaking capacity		0,3 W AgNi, 0,05 W AgNi/Au hard gold plating, 1 W AgSnO ₂
Contact resistance		≤ 100 mΩ
Max. operating frequency	AC1	• at rated load 600 cycles/hour
		• no load 72 000 cycles/hour

Coil data

Rated voltage	DC	5, 6, 9, 10, 12, 18, 24, 48 V
Must release voltage		DC: ≥ 0,1 U _n
Operating range of supply voltage		see Table 1 and Fig. 3
Rated power consumption	DC	0,25 W

Insulation according to EN 60664-1

Insulation rated voltage		400 V AC
Rated surge voltage		4 000 V 1,2 / 50 μs
Overvoltage category		III
Insulation pollution degree		3
Dielectric strength	• between coil and contacts	5 000 V AC type of insulation: reinforced
	• contact clearance	1 000 V AC type of clearance: micro-disconnection
Contact - coil distance	• clearance	≥ 10 mm
	• creepage	≥ 10 mm

General data

Operating / release time (typical values)		8 ms / 3 ms
Electrical life (number of cycles)	• resistive AC1	> 10 ⁵ 16 A, 230 V AC, 70 °C
		> 2 x 10 ⁴ 16 A, 230 V AC, 105 °C
		> 1,7 x 10 ⁵ 10 A, 230 V AC, 105 °C
		> 2,8 x 10 ⁵ 8 A, 230 V AC, 105 °C
		> 3,2 x 10 ⁵ 6 A, 230 V AC, 105 °C
	• cosφ	see Fig. 1
• DC L/R=40 ms	> 10 ⁵ 0,15 A, 220 V DC	
Mechanical life (cycles)		> 3 x 10 ⁷
Dimensions (L x W x H)		29 x 12,7 x 15,7 mm
Weight		14 g
Ambient temperature (non-condensation and/or icing)	• storage	-40...+105 °C
	• operating	-40...+105 °C
Cover protection category		IP 40 EN 60529
Environmental protection		RTII EN 61810-1
Shock resistance		30 g
Vibration resistance		10 g 10...150 Hz
Solder bath temperature		max. 270 °C
Soldering time		max. 5 s

The data in bold type relate to the standard versions of the relays. *The relays are designed for continuous operation while maintaining the parameters declared in the data sheet. **1** For single phase motors for 110-120 V AC do not use motors with higher FLA than given for 240 V AC.

RM85 105 °C sensitive miniature relays

Connection diagram (pin side view)

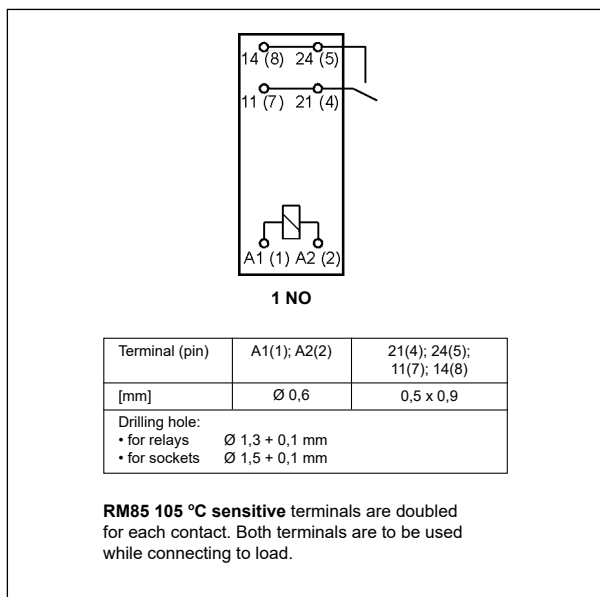

Connection of GZ.80 sockets

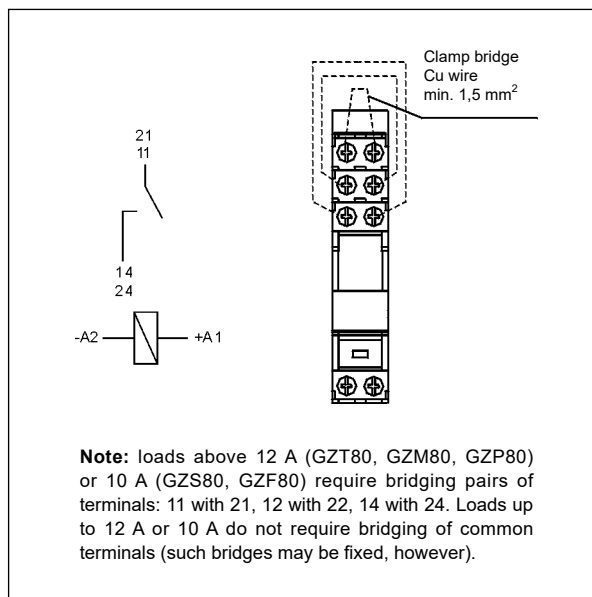

Mounting, sockets and accessories for relays

Relays **RM85 105 °C sensitive** are designed for: • direct PCB mounting • plug-in sockets.

Sockets for RM85 105 °C sensitive	Accessories			Additional equipment
	Retainer / retractor clips	Spring wire clips	Description plates	
Screw terminals sockets , 35 mm rail mount (acc. to EN 60715) or on panel mounting (one M3 screw)				
GZT80 ②	GZT80-0040, GZP80-0400	GZM80-0041	GZT80-0035	M... ④, ZGGZ80 ⑤
GZM80 ②	GZT80-0040, GZP80-0400	GZM80-0041	GZT80-0035	M... ④, ZGGZ80 ⑤
GZS80 ②	GZS-0040	GZM80-0041	TR	M... ④, ZGGZ80 ⑤
GZF80 ②	–	GZM80-0041	–	–
Push-in terminals sockets , 35 mm rail mount (acc. to EN 60715) or on panel mounting (one M3 screw)				
GZP80 ② ③	GZP80-0400, GZT80-0040	GZM80-0041	MP15	M... ④, ZGZP80-8, ZGZP80-2, ZGZP-2 ⑥
Sockets for PCB				
PW80	–	MH16-2	–	–
EW50	–	MP16-2 ⑥, MH16-2	–	–
EC 50	–	MP16-2 ⑥, MH16-2	–	–
GD50	–	MP16-2 ⑥, MH16-2, GD-0016	–	–

② Sockets GZ.80: load connection - see page 2. ③ Sockets GZP80: wire connection - see page 6. ④ Signalling / protecting modules type M... - see page 9. ⑤ Interconnection strips ZGGZ80, ZGZP... - see pages 10-11. ⑥ Plastic clips MP16-2.

RM85 105 °C sensitive miniature relays

Dimensions

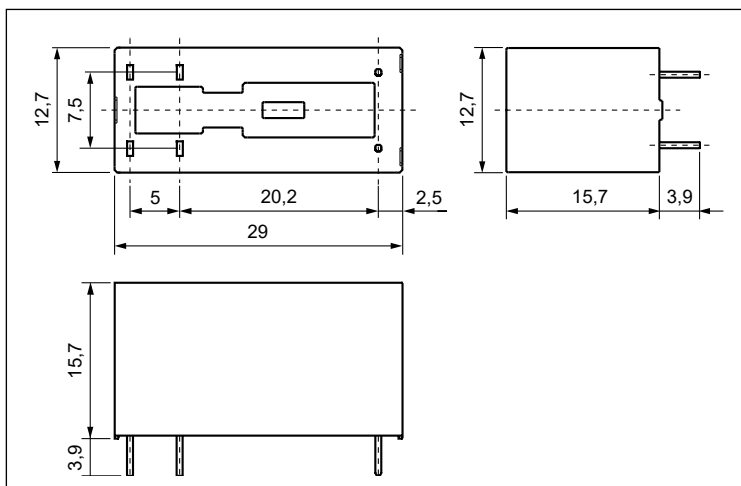

Pinout (solder side view)

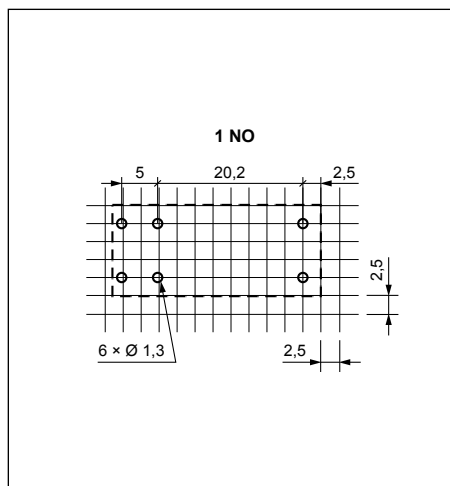

Electrical life reduction factor at AC inductive load

Fig. 1

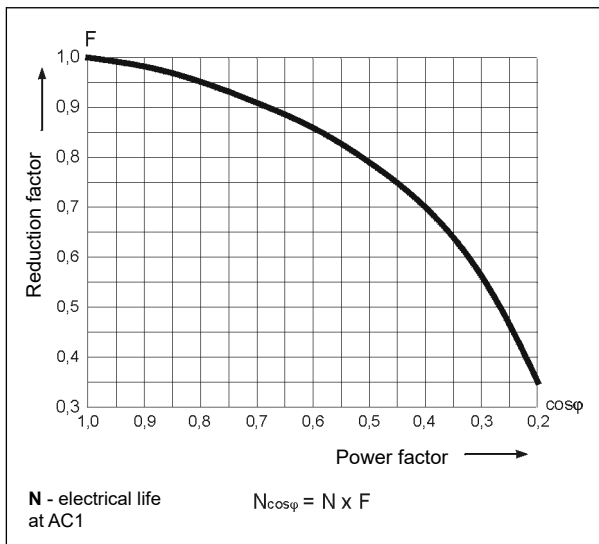

Max. DC resistive load breaking capacity

Fig. 2

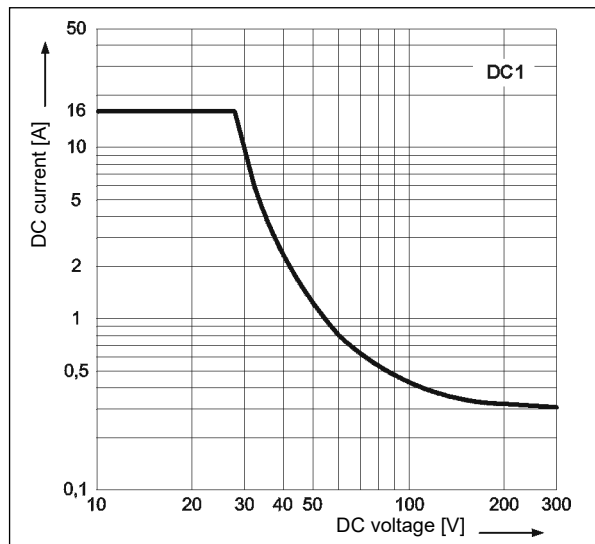

Coil operating range - DC

Fig. 3

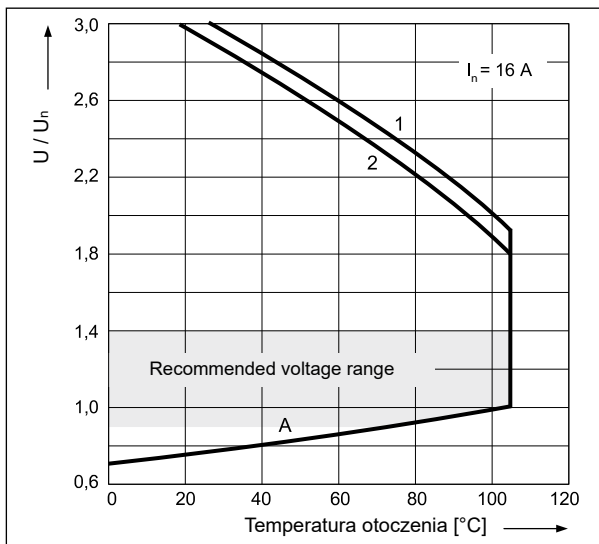

Description of Fig. 3

Using voltage other than the rated coil voltage may reduce the electrical life of the relay. Figure 3 shows the permissible voltage range for the relay coil, higher coil supply voltages may damage the coil insulation.

A - relations between make voltage and ambient temperature at no load on contacts. Coil temperature and ambient temperature are equal before coil energizing. Make voltage is not higher than the value read on Y axis (multiplication of rated voltage).

1, 2 - values on Y axis represent allowed overvoltage on coil at certain ambient temperature and contact load:

- 1 - no load
- 2 - rated load in AC1 category

RM85 105 °C sensitive miniature relays

Coil data - DC voltage version, sensitive

Table 1

Coil code	Rated voltage V DC	Coil resistance at 20 °C Ω	Acceptable resistance	Coil operating range V DC ⑦	
				min. (at 20 °C)	max. (at 20 °C)
S005	5	102	± 10%	3,75	15,0
S006	6	144	± 10%	4,50	18,0
S009	9	330	± 10%	6,75	27,0
S010	10	380	± 10%	7,50	30,0
S012	12	580	± 10%	9,00	36,0
S018	18	1 300	± 10%	13,50	54,0
S024	24	2 300	± 10%	18,00	72,0
S048	48	9 340	± 10%	36,00	144,0

⑦ The coil parameters are given for 20 °C and a relay with no load on the contacts. See details in Figure 3: permissible operating voltage range of the coil - DC voltage.

Ordering codes

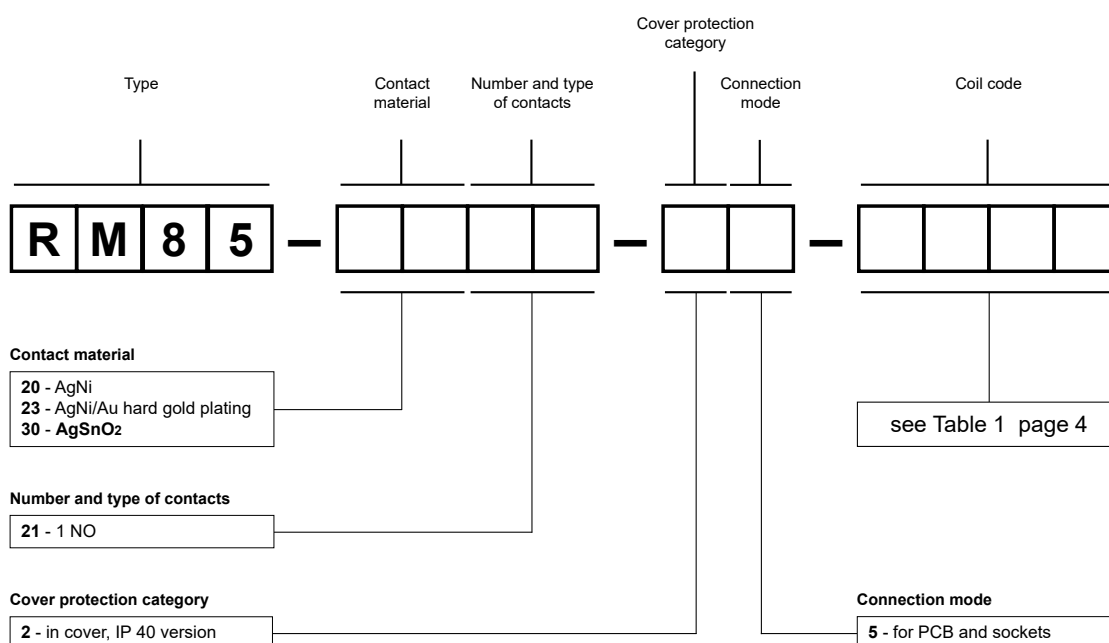

Examples of ordering code:

RM85-3021-25-S012

relay **RM85 105 °C sensitive**, for PCB and sockets, one normally open contact, contact material AgSnO₂, sensitive coil voltage 12 V DC, in cover IP 40

RM85-2321-25-S005

relay **RM85 105 °C sensitive**, for PCB and sockets, one normally open contact, contact material AgNi/Au hard gold plating, sensitive coil voltage 5 V DC, in cover IP 40

EW50, EW35

Plug-in sockets for PCB
for RM84, RM85, RM87
- see page 8

NEW

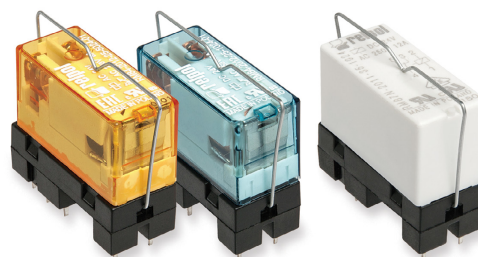

28.12.2023

Sockets and accessories

GZT80

For RM84, RM85, RM85 inrush, RM85 105 °C sensitive, RM87L, RM87L sensitive, RM87P, RM87P sensitive

Screw terminals
Max. tightening moment for the terminal: 0,7 Nm
35 mm rail mount acc. to EN 60715 or on panel mounting
80 x 15,6 x 61(67) mm
Two poles, 5 mm pinout
12 A, 300 V AC

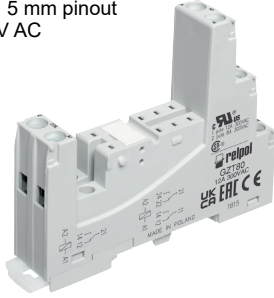

Connection diagrams ④

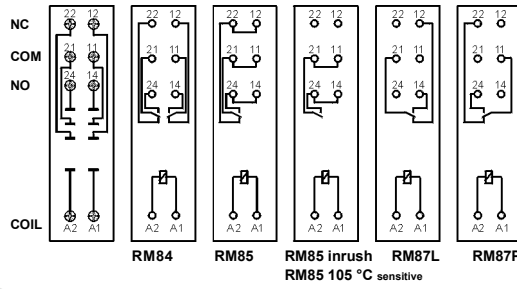

Accessories ①

ZGGZ80 GZM80-0041

Dimensions

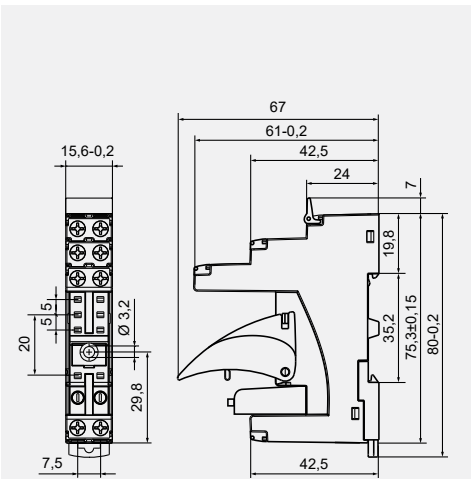

GZM80

For RM84, RM85, RM85 inrush, RM85 105 °C sensitive, RM87L, RM87L sensitive, RM87P, RM87P sensitive

Screw terminals
Max. tightening moment for the terminal: 0,7 Nm
35 mm rail mount acc. to EN 60715 or on panel mounting
81,6 x 15,9 x 61(67) mm
Two poles, 5 mm pinout
12 A, 300 V AC

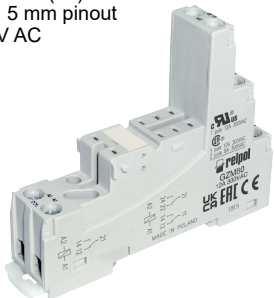

Connection diagrams ④

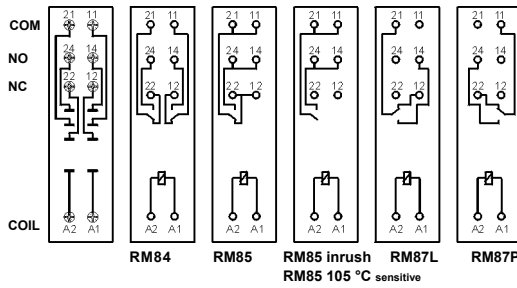

Accessories ①

ZGGZ80 GZM80-0041

Dimensions

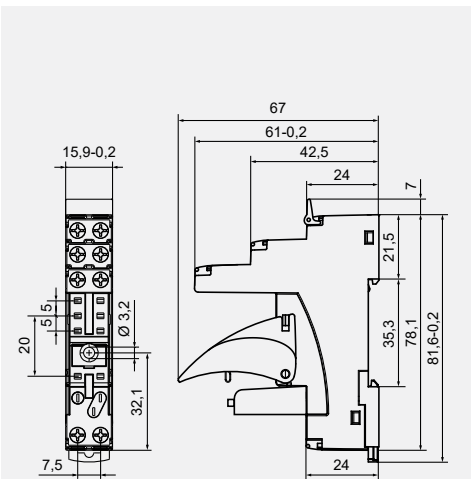

GZS80

For RM84, RM85, RM85 inrush, RM85 105 °C sensitive, RM87L, RM87L sensitive, RM87P, RM87P sensitive

Screw terminals
Max. tightening moment for the terminal: 0,5 Nm
35 mm rail mount acc. to EN 60715 or on panel mounting
76,8 x 15,8 x 42,5(57,1) mm
Two poles, 5 mm pinout
10 A, 300 V AC



Connection diagrams ④

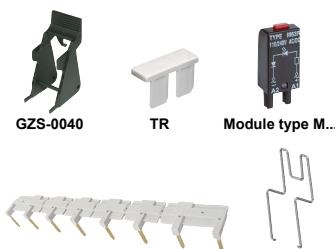
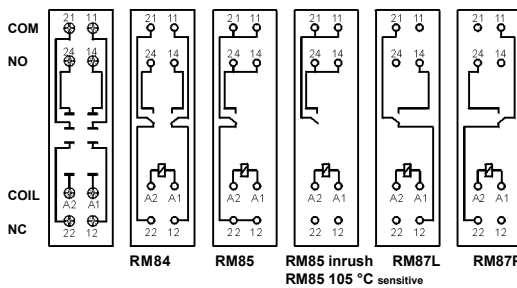

Accessories ①

ZGGZ80 GZM80-0041

Dimensions

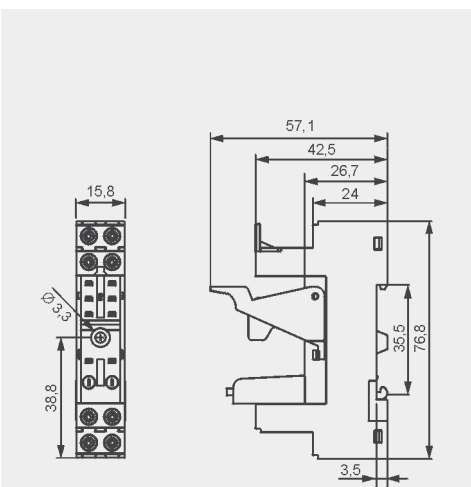

① Mounting and sub-assemblies of accessories in the socket - see page 7. Signalling / protecting modules type M... - see page 9. ② In the bracket the height of socket with retainer / retractor clip is shown. ④ For RM85..., RMP85: loads above 12 A (GZT80, GZM80, GZP80) or 10 A (GZS80, GZF80) require bridging pairs of terminals: 11 with 21, 12 with 22, 14 with 24 - see www.repol.com.pl

Sockets and accessories

GZP80

For RM84, RM85, RM85 inrush, RM85 105 °C sensitive, RM87L, RM87L sensitive, RM87P, RM87P sensitive, RMP84, RMP85

Push-in terminals (flammability class V-0)
Max. cross section of the cables:
2 x 1,5 mm² (ferrules without insulation)
2 x 1 mm² (ferrules with insulation)
Stripping length: 8... 10 mm

35 mm rail mount acc. to EN 60715 or on panel mounting
97 x 15,9 x 45,9(75,8) mm
5 mm pinout
One pole
12 A, 300 V AC
Two poles
8 A, 300 V AC



Accessories

Connection diagrams

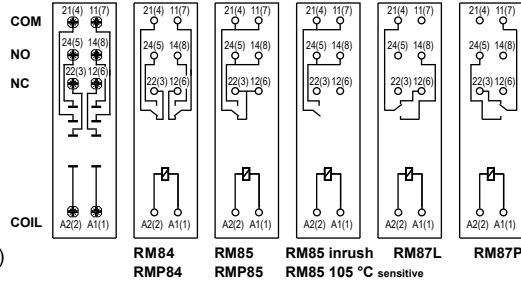

Dimensions

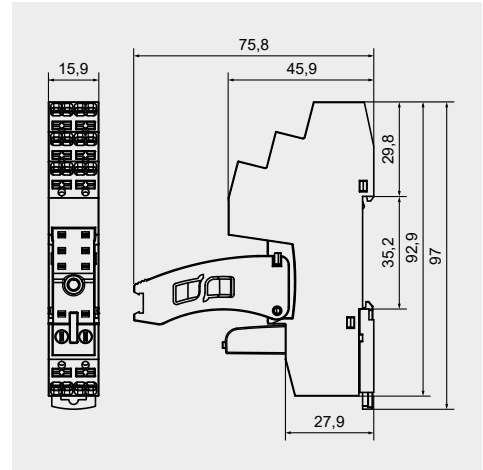

The drawings present inserting wire into the Push-in terminal and removing wire using the button releasing a clamp (assembly without tools).

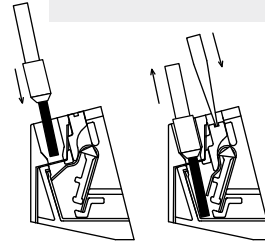

Wire connection

GZF80

For RM84, RM85, RM85 inrush, RM85 105 °C sensitive, RM87L, RM87L sensitive, RM87P, RM87P sensitive, RMP84, RMP85

Screw terminals
Max. tightening moment for the terminal: 0,5 Nm
35 mm rail mount acc. to EN 60715 or on panel mounting
67,2 x 15,5 x 36,5 mm
Two poles, 5 mm pinout
10 A, 250 V AC



Accessories

Connection diagrams

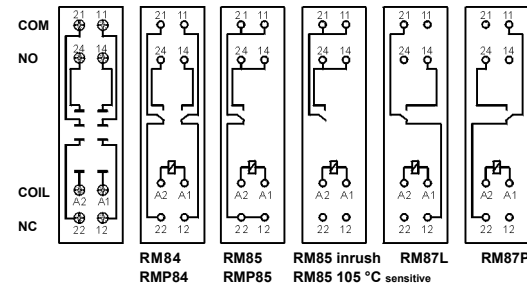

Dimensions

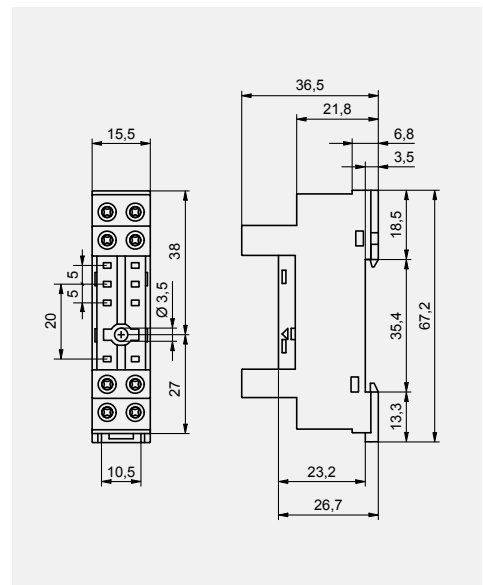

① Mounting and sub-assemblies of accessories in the socket - see page 7. Signalling / protecting modules type M... - see page 9. ② In the bracket the height of socket with retainer / retractor clip is shown. ③ For RM85..., RMP85: loads above 12 A (GZT80, GZM80, GZP80) or 10 A (GZS80, GZF80) require bridging pairs of terminals: 11 with 21, 12 with 22, 14 with 24 - see www.repol.com.pl



Mounting and sub-assemblies of the relay and accessories in the socket

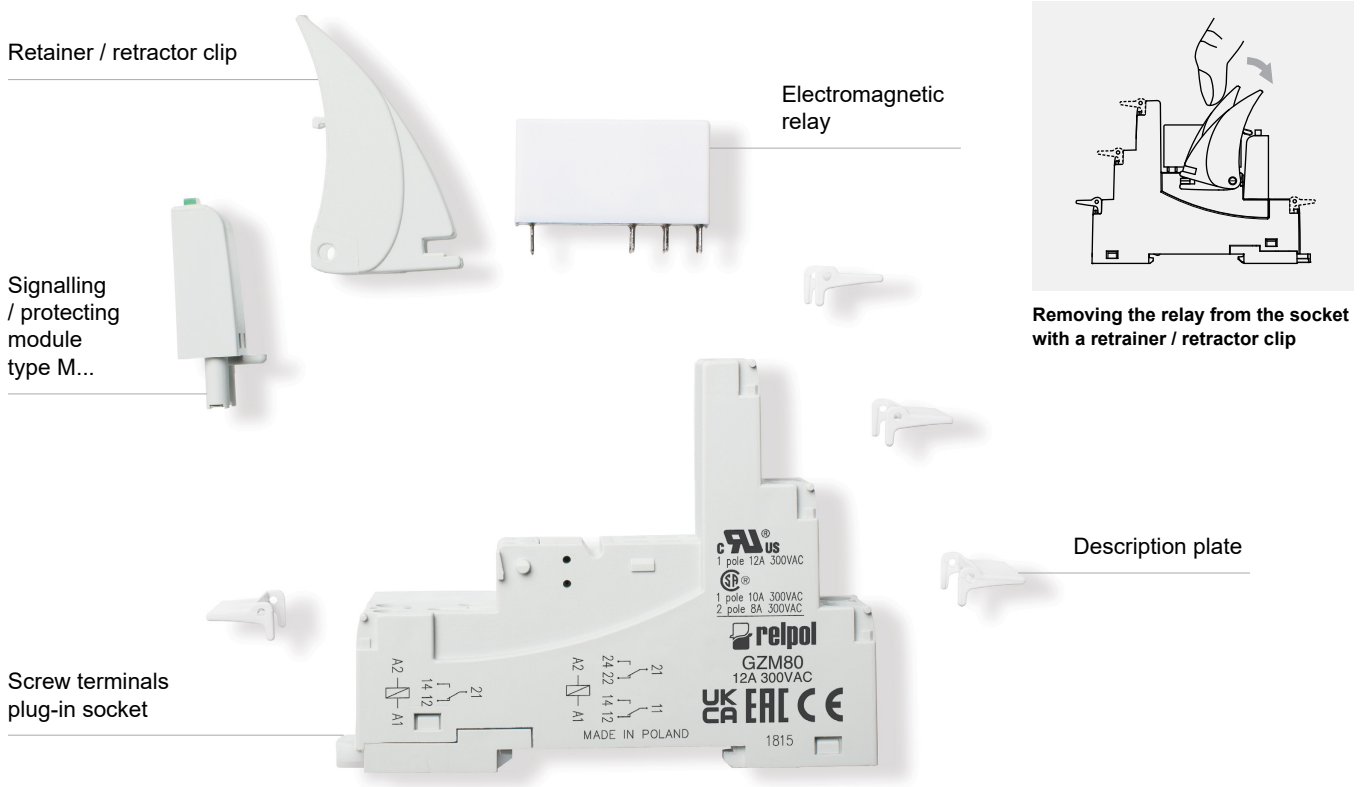

PRECAUTIONS:

1. Ensure that the parameters of the product described in its specification provide a safety margin for the appropriate operation of the device or system and never use the product in circumstances which exceed the parameters of the product. 2. Never touch any live parts of the device. 3. Ensure that the product has been connected correctly. An incorrect connection may cause malfunction, excessive heating or risk of fire. 4. In case of any risk of any serious material loss or death or injuries of humans or animals, the devices or systems shall be designed so to equip them with double safety system to guarantee their reliable operation.

Sockets and accessories

PW80

For RM84, RM85, RM85 inrush, RM85 105 °C sensitive, RM87L, RM87L sensitive, RM87P, RM87P sensitive, RM83

For PCB
34,6 x 12,9 x 6,6 mm
Two poles, 5 mm pinout
12 A, 250 V AC

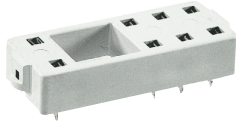

Pinout

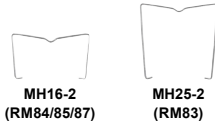
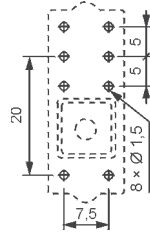

Accessories

Dimensions

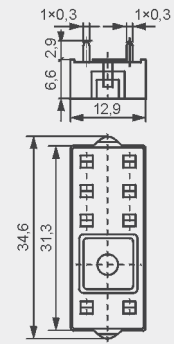

ERC

EW50

For RM84, RM85, RM85 inrush, RM85 105 °C sensitive, RM87L, RM87L sensitive, RM87P, RM87P sensitive, RM83, RMP84, RMP85

For PCB
30,2 x 13 x 9,4 mm
Two poles, 5 mm pinout
10 A, 250 V AC

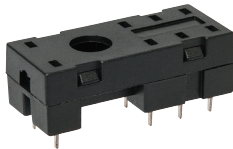

Pinout

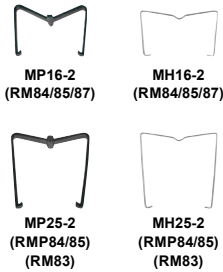
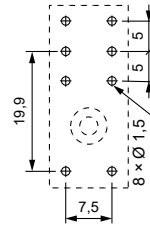

Accessories

Dimensions

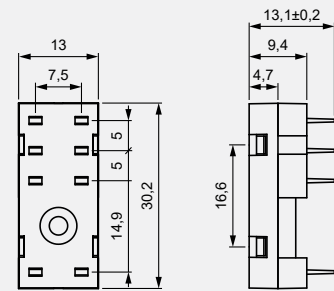

ERC

EC 50

For RM84, RM85, RM85 inrush, RM85 105 °C sensitive, RM87L, RM87L sensitive, RM87P, RM87P sensitive, RM83, RMP84, RMP85

For PCB
31,3 x 12,7 x 9 mm
Two poles, 5 mm pinout
12 A, 250 V AC

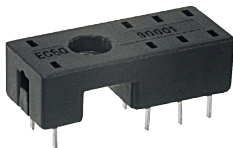

Pinout

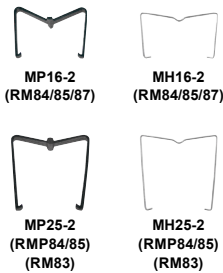
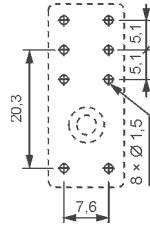

Accessories

Dimensions

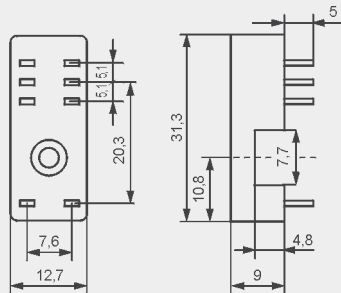

ERC

GD50

For RM84, RM85, RM85 inrush, RM85 105 °C sensitive, RM87L, RM87L sensitive, RM87P, RM87P sensitive, RM83, RMP84, RMP85

For PCB
31,5 x 13 x 9 mm
Two poles, 5 mm pinout
8 A, 300 V AC



Pinout

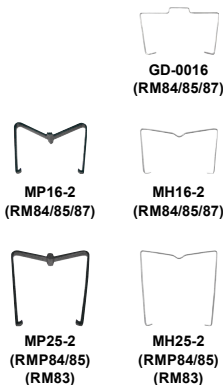
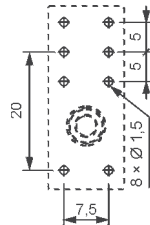

Accessories

Dimensions

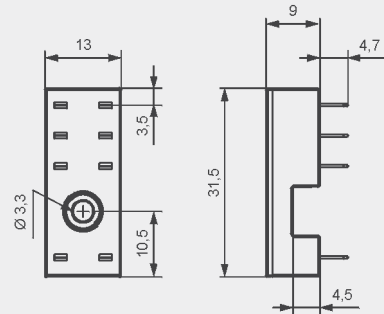

ERC

Signalling / protecting modules type M...

For sockets type:

GZT80, GZM80, GZS80, GZP80, GZT92, GZM92, GZS92, ES 32, GZT2, GZM2, GZT3, GZM3, GZT4, GZM4, GZP4

Modules type M... are parallelly connected with relay coil.

Polarization P: -A1/+A2. Polarization N: +A1/-A2.

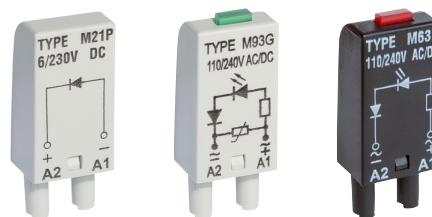

Modules type M...	Layout	Voltage	Type of module ① ②
Module D (polarization P) It limits overvoltage on DC coils.		6/230 V DC	M21P
Module D (polarization N) It limits overvoltage on DC coils.		6/230 V DC	M21N
Module LD (polarization P) It limits overvoltage on DC coils. Coil energizing indication.		6/24 V DC 24/60 V DC 110/230 V DC	M31R, M31G M32R, M32G M33R, M33G
Module LD (polarization N) It limits overvoltage on DC coils. Coil energizing indication.		6/24 V DC 24/60 V DC 110/230 V DC	M41R, M41G M42R, M42G M43R, M43G
Module RC It protects against EMC disturbance. It limits overvoltage.		6/24 V AC/DC 24/60 V AC/DC 110/240 V AC/DC	M51 M52 M53
Module L Coil energizing indication.		6/24 V AC/DC 24/60 V AC/DC 110/240 V AC/DC	M61R, M61G M62R, M62G M63R, M63G
Module LV It limits overvoltage on AC and DC coils. Coil energizing indication.		6/24 V AC/DC 24/60 V AC/DC 110/240 V AC/DC	M91R, M91G M92R, M92G M93R, M93G
Module V It limits overvoltage on AC coils. No indication.		6/24 V AC 110/130 V AC 220/240 V AC	M71 M72 M73
Module R It limits harmful voltage on AC coils induced in long lines which causes unwanted making of the relay.		110/240 V AC	M103

① M...R - LED red, M...G - LED green

② When ordering modules indicate their color: gray or black.

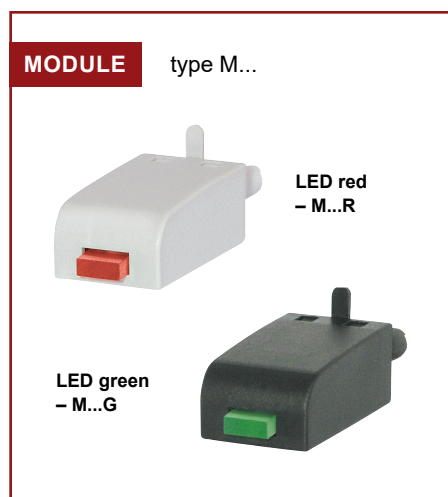

Interconnection strips ZGGZ80



PI85-...-MS-...
(RM85 + GZM80)

ZGGZ80

ZGGZ80 for:

Plug-in sockets	Relays for plug-in sockets	Interface relays ^③
GZT80	RM84, RM85, RM85 inrush, RM85 105 °C sensitive, RM87L ^④ , RM87P ^④ , RM87N ^④	PI84-...-TS-... (RM84 + GZT80)
GZM80		PI84-...-MS-... (RM84 + GZM80)
GZS80		PI85-...-TS-... (RM85 + GZT80)
GZT92		(RM85 inrush + GZT80)
GZM92		PI85-...-MS-... (RM85 + GZM80)
GZS92		
ES 32	RM96 1 CO	

^③ Interface relay **PI84 (PI85)** is offered as a **set**: electromagnetic relay **RM84 (RM85)** + plug-in socket **GZT80** or **GZM80** + signalling / protecting module type **M...** + retainer / retractor clip **GZT80-0040** + description plate **GZT80-0035**. ^④ Also versions RM87. sensitive

Interconnection strip ZGGZ80

- designed for the co-operation with plug-in sockets of miniature relays and with interface relays PI84 and PI85, which are equipped with screw terminals; sockets and relays are mounted on 35 mm rail mount acc. to EN 60715,
- bridges common input signals (coil terminals A1 or A2) or output signals - see photo at the top,
- maximum permissible current is 10 A / 250 V AC,
- possibility of connection of 8 sockets or relays,
- colours of strips: **ZGGZ80-1** grey, **ZGGZ80-2** black.

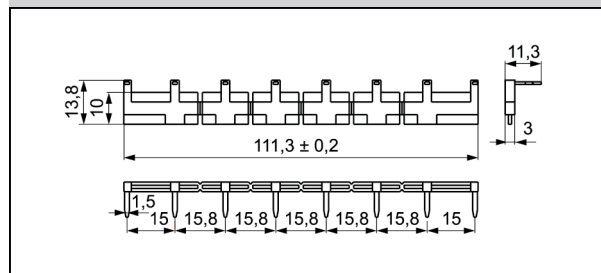
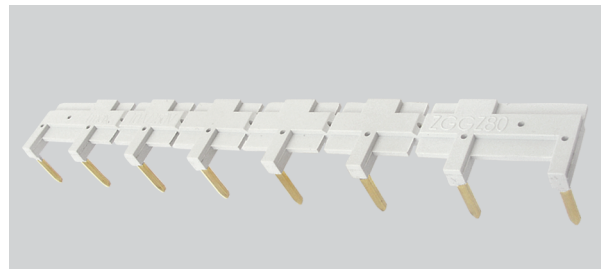

Interconnection strips ZGZP... for sockets GZP80

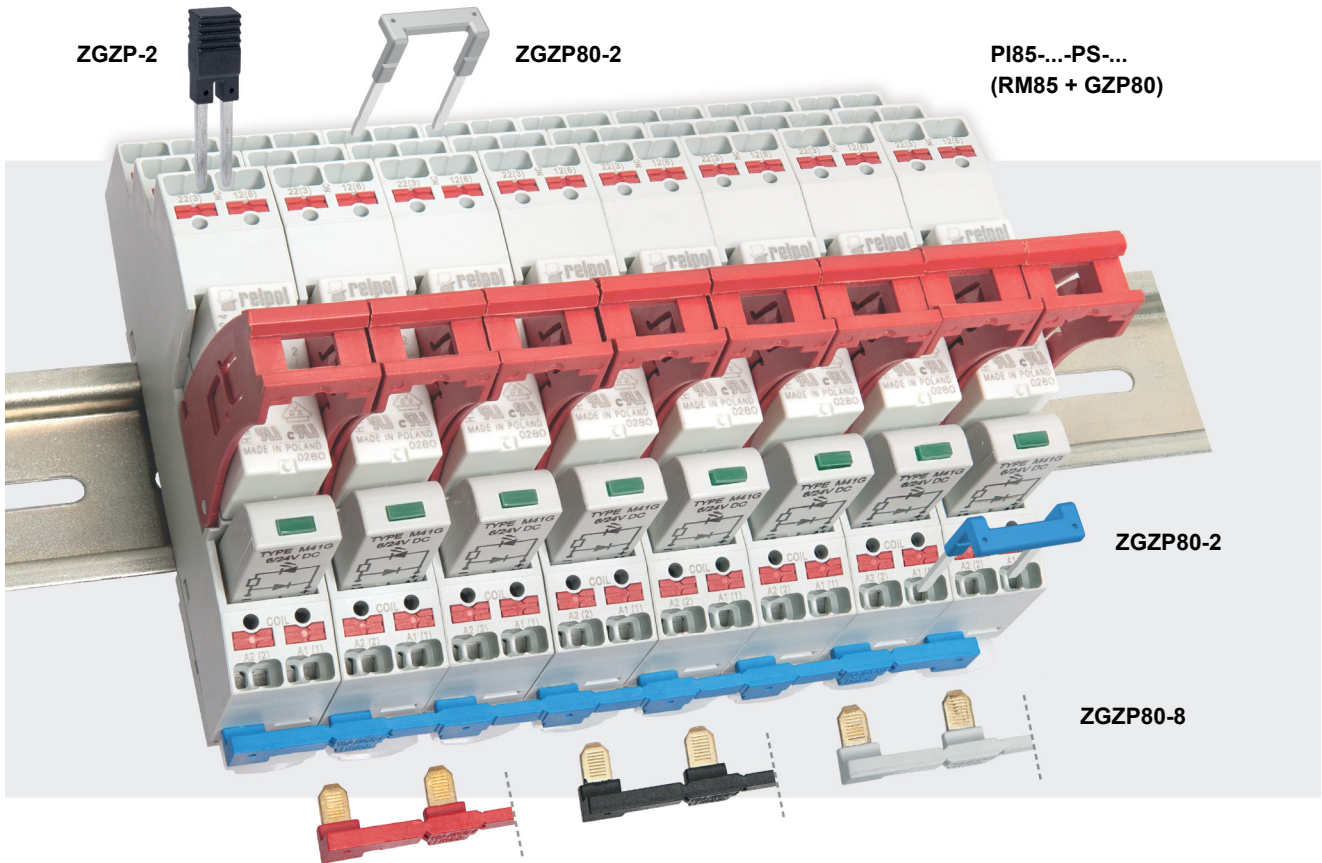

■ ZGZP... for:

Plug-in sockets	Relays for plug-in sockets	Interface relays ⑤
GZP80	RM84, RM85, RM85 inrush, RM85 105 °C sensitive, RM87L ④, RM87P ④, RMP84, RMP85	PI84-...-PS-... (RM84 + GZP80) PI85-...-PS-... (RM85 + GZP80) PI84P-...-PS-... (RMP84 + GZP80) PI85P-...-PS-... (RMP85 + GZP80)

⑤ Interface relay **PI84** (**PI85**, **PI84P**, **PI85P**) is offered as a **set**: electromagnetic relay **RM84** (**RM85**, **RMP84**, **RMP85**) + plug-in socket **GZP80** + signalling / protecting module type **M...** + retainer / retractor clip **GZP80-0400**.
④ Also versions RM87. sensitive

■ Interconnection strips ZGZP...

- designed for the co-operation with plug-in sockets of miniature relays and with interface relays PI84, PI85, PI84P, PI85P, which are equipped with Push-in terminals; sockets and relays are mounted on 35 mm rail mount acc. to EN 60715,
- strip **ZGZP80-8** bridges common input signals (coil terminals A1 or A2), maximum permissible current is 10 A / 250 V AC, possibility of connection of 8 sockets or relays,



- strip **ZGZP80-2** bridges common input signals (coil terminals A1 or A2) or output signals, possibility of connection of 2+n sockets or relays,



- jumper **ZGZP-2** bridges the neighboring poles of single socket **GZP80** (usage of jumpers ZGZP-2 in interface relays Push-in PI85, PI85P increases load capacity of socket from 12 A to 16 A).

